

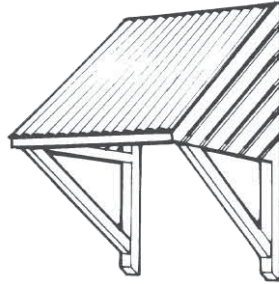

**Woodworkers' Standard Paling Skillion**  
Overhang 565 mm  
Height 1300 mm  
WH 1

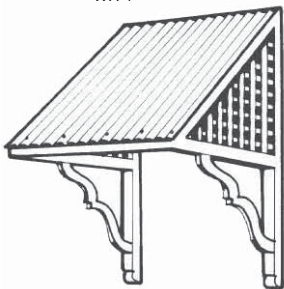

**Woodworkers' Diagonal Skillion**  
Overhang 565 mm  
Height 1300 mm  
WH 2



**Woodworkers' Lattice Skillion**  
Overhang 565 mm  
Height 1300 mm  
WH 3

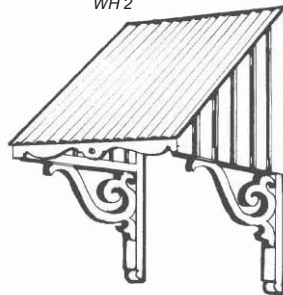

**Woodworkers' Sweep Skillion**  
Shown with fretwork fascia option  
Overhang 565 mm  
Height 1300 mm  
WH 4

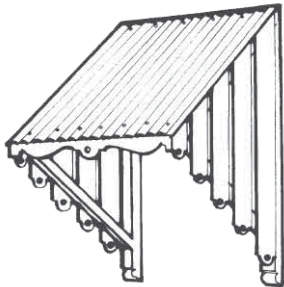

**Woodworkers' Florentine Paling**  
Shown with fretwork fascia option  
Overhang 565 mm  
Height 1300 mm  
WH 5



**Woodworkers' Fretwork Paling Skillion**  
Overhang 565 mm  
Height 1300 mm  
WH 6

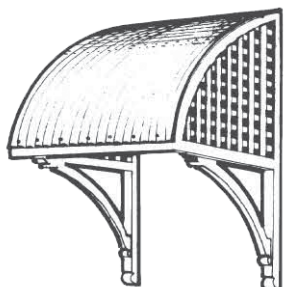

**Woodworkers' Bullnose Lattice**  
Overhang 565 mm  
Height 1300 mm  
WH 7

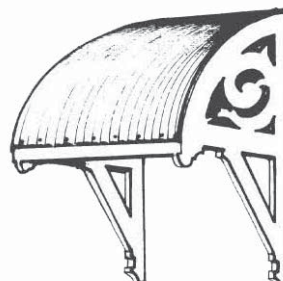

**Woodworkers' Fretwork Bullnose**  
Overhang 460 mm  
Height 920 mm  
WH 8



**Woodworkers' Scallop**  
With fretwork fascia and finials  
Overhang 565 mm  
Height 1300 mm  
WH 9



**Woodworkers' Sunrise Skillion**  
Overhang 565 mm  
Height 1300 mm  
WH 10

Surprisingly, window hoods came into general usage only at the end of the nineteenth century as Queenslanders belatedly adapted their houses for the tropical climate. They remained popular until the 1930's, becoming progressively less elaborate with time. The Woodworkers' Company makes metal hoods as pre-assembled units or supplies timber hood designs as either complete kits (incorporating metalwork, screws and flashings) or as timberwork only components. Special hood designs can be quoted, if required.

### TIMBER & TIN HOOD PRICE LIST (inc GST)

Width	Stock WH1		Custom WH1 & 2		WH 3,4 & 6		WH7,8 & 9		WH 10		Extra for fretwork fascia
	timber work only	complete kit	timber work only	complete kit	timber work only	complete kit	timber work only	complete kit	timber work only	complete kit	
Up to 1000mm	\$187	\$245	\$225	\$265	\$235	\$275	\$240	\$310	\$275	\$330	\$35
1001 - 1500mm	\$194	\$259	\$235	\$285	\$245	\$300	\$250	\$350	\$295	\$350	\$40
1501 - 2000mm	\$210	\$288	\$250	\$310	\$265	\$325	\$270	\$390	\$310	\$375	\$45
2001 - 3000mm	\$238	\$341	\$285	\$365	\$295	\$375	\$300	\$510	\$345	\$425	\$50
3001 - 3500mm	\$260	\$379	\$315	\$410	\$325	\$420	\$325	\$525	\$370	\$510	\$55
3501 - 4500mm	\$296	\$437	\$350	\$465	\$360	\$475	\$390	\$645	\$415	\$525	\$65

- Kit hoods are supplied unassembled.
- Preprimed white stock WH1 sides 15% extra subject to availability.
- Timberwork only option includes prefabricated sides and cross purlins only.
- Kit includes all timberwork, galvanized sheeting, flashing, gable roll & roof screws.
- Zincalume 10% extra, Colorbond or mini orb 20% extra.
- Bullnose designs do not include gable roll.



the best value hoods you'll find!

Website: [www.woodworkers.com.au](http://www.woodworkers.com.au)

Email: [sales@woodworkers.com.au](mailto:sales@woodworkers.com.au)

**BRISBANE**  
1095 Ipswich Rd  
Moorooka 4105  
☎ 07 3848 1383  
F: 07 3892 1476

**GOLD COAST**  
Warehouse Road  
Southport 4215  
☎ 07 5571 0088  
F: 07 5571 0617

**SUNCOAST**  
53 Wisers Road  
Maroochydore  
☎ 07 5479 0999  
F: 07 5479 0911

**SYDNEY**  
2 Sydenham Rd  
Brookvale 2100  
☎ 02 9938 4999  
F: 02 9938 4666

# WINDOW HOODS FREQUENTLY ASKED QUESTIONS

The current version of this document is on the internet. Printed version & prices may be superseded. All material subject to copyright.

## TIMBER & IRON HOODS

### WHAT IS THE CONSTRUCTION OF TIMBER & IRON HOODS?

All Woodworkers hoods are made of externally durable hardwoods (not pine) and often premium timbers e.g. red cedar, kwila are used to recycle smaller off-cuts from our joinery workshop. Timber hoods are supplied as raw timber in kit form for site assembly by others as they are generally too heavy and bulky for workshop fabrication. Window hood kits are supplied as either timberwork only (excluding all metalwork) or as complete kits including flashings, iron roofing and roof fixing screws. A choice of standard galvanised steel, zincalume or colorbond is available in either standard profile or mini orb, although significant cost surcharges and lead times may apply to mini orb options. All fixings used in window hoods are coated to resist corrosion.

### HOW ARE TIMBER HOODS INSTALLED?

Timber hoods are generally constructed on site in the same sequence as you would use to build a roof. Because timber hoods are relatively heavy and bulky it is usually preferable to construct them in position rather than prefabricate them on the ground and have to manipulate them over scaffold into position. The two sides are usually positioned either side of the joinery to enable solid fixing (batten screws) into the stud framing around the joinery. The purlins can then be accurately cut to fit the sides and batten screwed into position to create a sturdy frame for installation of the metalwork. It is preferable if all timberwork is fully primed or finished before installation as it is safer and simpler to do this work at ground level. The size of the purlins needs to comply with the Australian Standard AS1684.2 – 2006 for the wind classification applicable to the locality using F17 unseasoned hardwood (Supplement 15).

The following table is provided as a guide but should be checked by your engineer particularly in heavy exposed or cyclonic areas.

Size ( H x W )	Max span
75 x 38	1600mm
75 x 50	1900mm
100 x 38	2500mm
100 x 50	2900mm
125 x 38	3600mm
125 x 50	3900mm
150 x 38	4300mm
150 x 50	4500mm

The metal work is fixed to the timber structure in accordance with the same code requirements used for the roof, usually requiring nylon washered hex head roof screws. Woodworkers do not arrange installations of hoods but can recommend a BSA registered builder to undertake the work directly contracting with you if required.

### CAN WOODWORKERS MAKE SPECIAL DESIGN TIMBER WINDOW HOODS?

Yes. If matching of existing hoods is required we will need photographs and a template to follow, or one side of an existing hood. We do not undertake site measurement of hoods. If you want to design your own hoods, we can work from detailed drawings provided by you.

### DO TIMBER HOODS COME WITH DECORATIVE FASCIAS?

No. Even if the design shown overleaf shows a decorative fascia e.g. WH4 & 9, the kit price does not include this feature. A separate price column is included for fascias in the price list and any design can include this if requested at the time of ordering.

### DOES WOODWORKERS CARRY STOCKS OF ALL WINDOW HOODS?

No. All metal hoods are custom made and only the WH1 Standard Paling Skillion design is generally held in stock for immediate supply. All other hoods usually require a lead time of 3 to 4 weeks, which can be extended in peak periods

## INSTALLATION



STEP 1



STEP 2

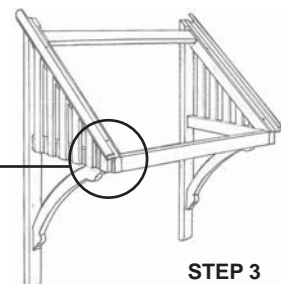

STEP 3



STEP 4



STEP 5

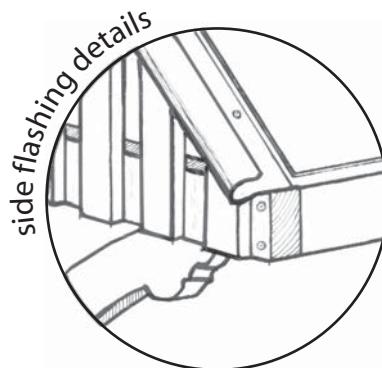

## METAL HOODS

### WHAT IS THE CONSTRUCTION OF METAL HOODS?

Woodworkers metal hoods come in two forms

1. galvanised steel
2. colorbond zinalume

The primary difference is, of course, the pre-finishing of colorbond hoods but both are equally durable. Galvanised steel hoods are made from 0.4mm (26 gauge) thick steel and are made with traditional solder joints. Colorbond hoods can only be connected by pop rivet joints and are slightly more expensive due to increased material and labour costs. Any current colorbond colour can be chosen for any metalwork feature, including roof vents, hoods, rainwater heads etc. but it is important that water does not run over zinalume onto galvanised product as electrolytic corrosion will occur. You should choose the same material as your roof for gutters, hoods and embellishments to avoid electrolytic problems. Water flow from galvanised to zinalume is acceptable but not the reverse.

### ARE SPECIAL DESIGNS TO MATCH EXISTING HOODS POSSIBLE?

Yes. In general we will require either the old hood to be duplicated or a template of the sides and key decoration with photographs to match existing hoods. There is a surcharge of approx 20% for custom work but this may increase with complex designs. Woodworkers do not site measure existing hoods. Special work in other metals e.g. copper can be priced if required.

### ARE METAL HOODS SITE DELIVERED?

Usually yes. Metal hoods and roof products are extremely fragile until such time as they are installed in their final position. In metro Brisbane and regional locations near our showrooms delivery is usually not a problem but for country or interstate locations special arrangements are necessary. It has been our experience that metalwork goods are too delicate for normal road transport companies and that fully insured delivery by furniture removalists offers the best chance of success. Special boxing can be arranged at significant expense (if required) but no packaging is provided as standard with metalwork products and it is essential that special top load arrangements are agreed with your proposed carrier. Where you have many hoods the same size, it is preferable that they be adjusted in size in approx 30mm width increments to allow them to be packed inside each other for transport. Our staff can assist with precise increments for your chosen hood design in consultation with our fabrication shop if requested.

### DO ROOF VENTILATORS REALLY WORK?

Traditionally roof vents are installed at the apex of the roof to let hot air escape. Roof vents are provided as cylinders which need to be fitted and flashed by a tradesman roof plumber to be effective and weathertight. They are not generally suitable for DIY installations as they require carefully fitted flashings to all adjacent work to both secure them in position and prevent leakage. Where an updraught is essential to extract air, roof vents can be custom manufactured to incorporate a 'whirly bird' extraction device or electric fan at additional expense. As with all custom work, lead times of 4 to 6 weeks may be required.

### DOES WOODWORKERS ARRANGE INSTALLATION?

No. You will require a specialist roof plumber to undertake installation of ventilators, acroterias, horns, spikes, cappings and rain water heads. Your carpenter will normally install window hoods but, if required, a BSA registered builder can be recommended by our showroom staff to undertake the work required.

### HOW ARE METAL HOODS INSTALLED?

Metal hoods should clear the external jambs of joinery by approximately 30mm and are usually simply screwed directly to the chamferboards with dome head screws & nylon washers to ensure electrolytic compatibility with the hood metal. Remember water cannot flow over zinalume onto galvanised fixings. Because metal hoods are so light they can easily be installed by two people in a fully assembled state. The metal hood needs to be positioned to avoid interference with the window opening (especially with casements) and ensure pedestrian traffic cannot collide with the hood. Ensuring the hood and window are parallel, the top flange of the hood is usually slipped under the chamferboard or weatherboard overlap and the sides are screwed down with 3 to 4 screws each side.

## INSTRUCTIONS

### STEP 1

Fix both sides of hood either side of window ensuring solid anchor into wall studs. Fix with 3 battenscrews each side or suitable masonry anchors for brick/block walls. Position the top of the hood to ensure it will not interfere with the opening of the window.

### STEP 2

Measure and cut purlins to fit tightly between window hood sides, predrill each purlin end for two batten screws and fix off to create a solid roof frame.

### STEP 3

Measure and cut side flashing with angle on top end to fit snugly to wall. Screw fix flashings in place.

### STEP 4

Lay out roof sheeting, overlapping stock sheets as necessary to achieve the desired width. Fix roof sheeting every 4th corrugation with roof hex head screws. Position top fixings to ensure they do not interfere with the back flashing installation.

### STEP 5

Measure and cut back flashing to sit neatly between side flashing. Scribing of flashing to the corrugation is not usually required. The rear flange is either trimmed to sit in weatherboard overlap, mortar coursing or face fixed into a silicone bed.

# 11 METAL WINDOW HOODS

The current version of this document is on the internet. Printed version & prices may be superseded. All material subject to copyright.

**THE  
WOODWORKERS  
COMPANY**

Our metal window hoods are made to order from 0.4 mm (26 gauge) galvanised steel or colorbond. Apart from the standard designs illustrated, we can match existing hoods as required for a small additional charge.

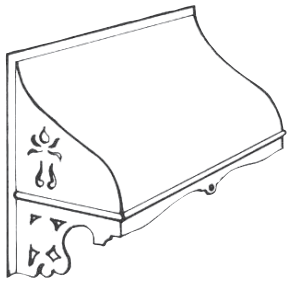

Woodworkers' Ogee No.1  
Overhang 480mm Height 830mm  
MH1

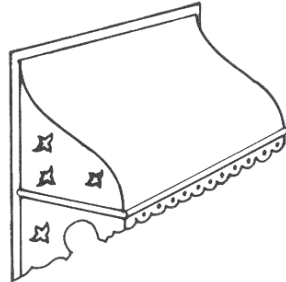

Woodworkers' Ogee No.2  
Overhang 480mm Height 810mm  
MH2

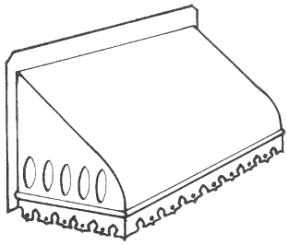

Woodworkers' Bullnose No.1  
Overhang 470mm Height 440mm  
MH3

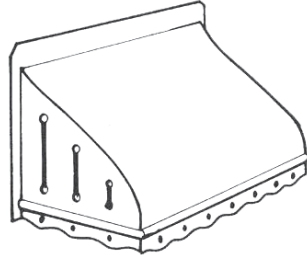

Woodworkers' Bullnose No.2  
Overhang 480mm Height 560mm  
MH4

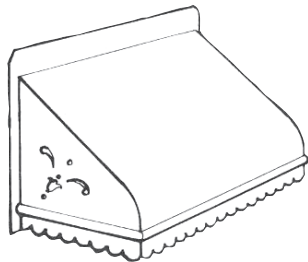

Woodworkers' Bullnose No.3  
Overhang 480mm Height 560mm  
MH5

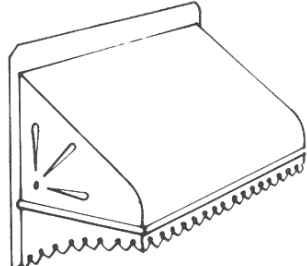

Woodworkers' Bullnose No.4  
Overhang 480mm Height 620mm  
MH6

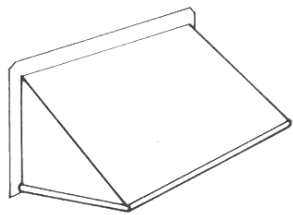

Woodworkers' Skillion No.1  
Overhang 450mm Height 380mm  
MH7

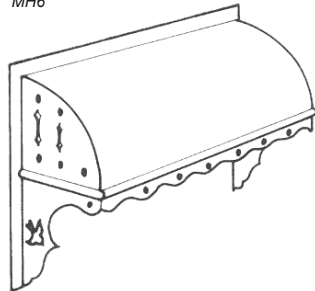

Woodworkers' Drumroll No.1  
Overhang 420mm Height 630mm  
MH8

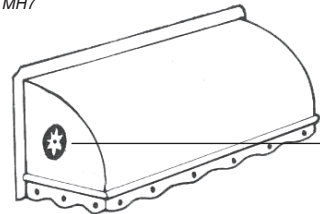

Woodworkers' Drumroll No.2  
Overhang 450mm Height 425mm  
MH9

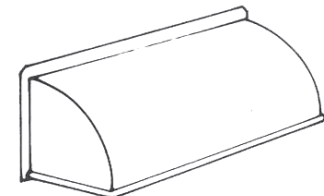

Woodworkers' Drumroll No.3  
Overhang 450mm Height 380mm  
MH10

### ALTERNATE CUT-OUT DESIGNS



Kangaroo

Koala

Kookaburra

Daisy

Emu

Sun

### METALWORK PRICE LIST (INC GST)

Window Hoods	Galv	Colorbond
Up to 1199mm	\$231	\$323
1200-1799mm	\$254	\$347
1800 - 2399mm	\$262	\$362
2400 - 2999mm	\$323	\$416
3000 - 3700mm	\$439	\$531
Special customer designs extra	20%	
Large roof ventilators	\$262	\$385
Small roof ventilators	\$246	\$370
Acroterias	\$31	\$40
Ridge Horn	\$123	\$177
Square Rainwater head	\$169	\$223
Roof spikes	\$216	
Hexagonal rainwater head	\$200	
Ridge capping per metre	\$77	

**please click  
here for  
available  
COLORBOND  
options**

**INCLUDES  
GST**

### ROOF EMBELLISHMENT

Roof ventilators and classically inspired embellishments were most popular from the early 1880's until World War I. Although originally designed to convection cool and dignify large pyramid roofs, they have become synonymous with the tropical colonial style.

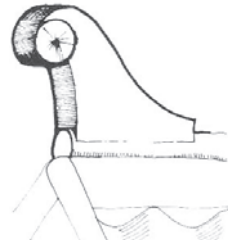

Woodworkers' Ridge Horn  
Height 270mm  
Length 300mm  
RE2

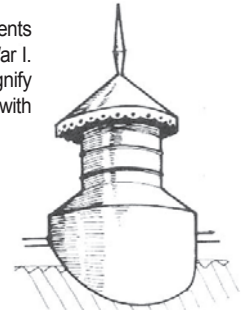

Woodworkers' Roof Ventilator  
Small - Height 980mm  
min. diameter - 200mm Base diameter 360mm  
Large - Height 1200mm  
min. diameter - 280mm Base diameter 500mm  
RE1

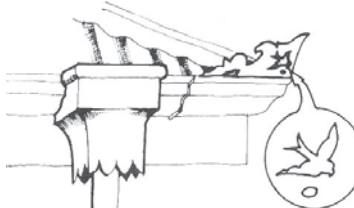

Woodworkers' Gutter Acroteria No.1  
Height 135mm  
Length 360mm  
RE3

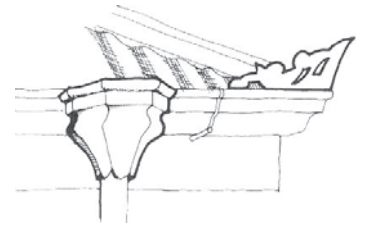

Woodworkers' Gutter Acroteria No.2  
Height 135mm  
Length 360mm  
RE4

Woodworkers' Square Rainwater Head  
Height 330mm  
Width 340mm  
RE5

Woodworkers' Hexagonal Rainwater Head  
Height 370mm  
Width 350mm  
RE6

Woodworkers' Roof Spike No.1  
Height 600mm  
Width 140mm  
RE7

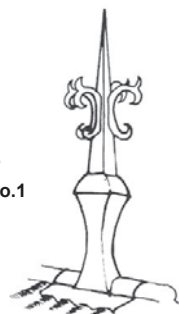

Woodworkers' Roof Spike No.2  
Height 600mm  
Width 400mm  
RE8

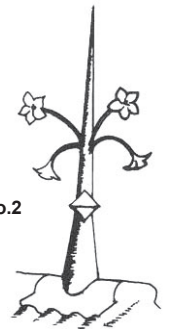

### RIDGE CAPPING TYPES

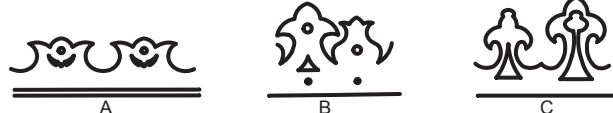

A

B

C



**BRISBANE**  
1095 Ipswich Rd  
Moorooka 4105  
☎ 07 3848 1383  
✉ 07 3892 1476

**GOLD COAST**  
Warehouse Road  
Southport 4215  
☎ 07 5571 0088  
✉ 07 5571 0617

**SUNCOAST**  
53 Wisers Road  
Maroochydore  
☎ 07 5479 0999  
✉ 07 5479 0911

**SYDNEY**  
2 Sydenham Rd  
Brookvale 2100  
☎ 02 9938 4999  
✉ 02 9938 4666

# INSTRUCTIONS FOR INSTALLATION OF PRIVACY SCREENS

Paint prime all timberwork before assembling screen.

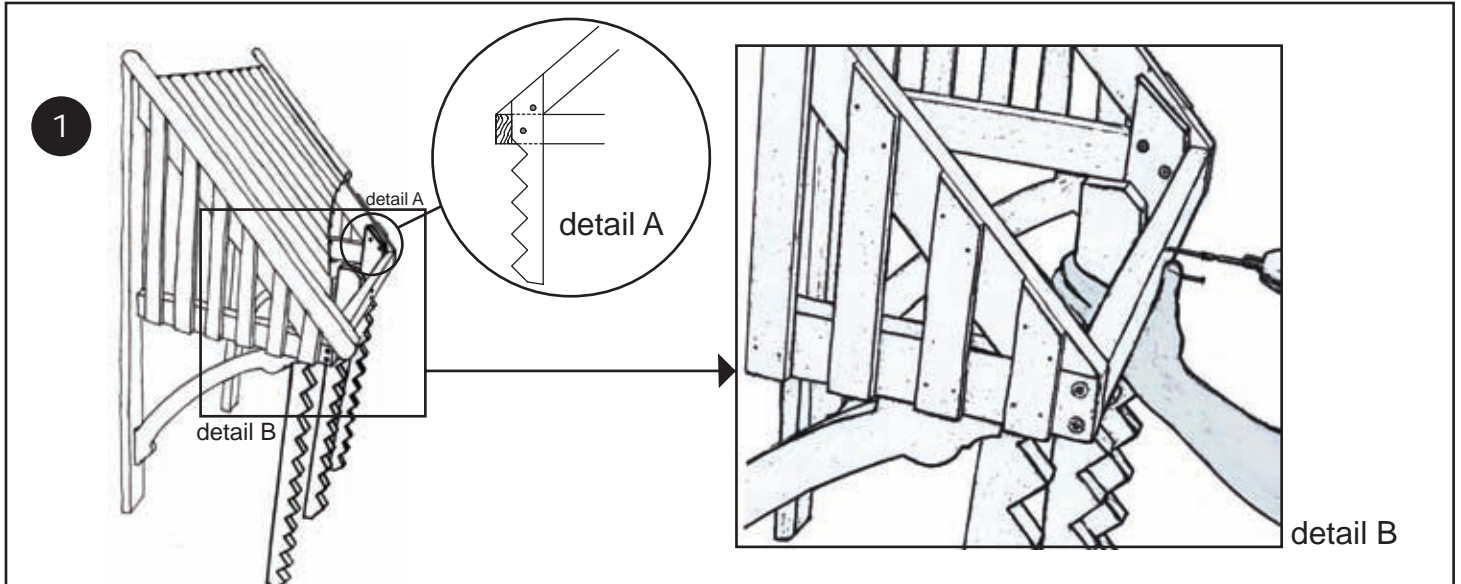

Privacy screens are supplied as kits for DIY assembly and installation on site. Screw uprights to inside of window hood framework as per detail A. Where span of louvre blade exceeds 1 meter, one or more central uprights will be required to be screwed to inside of purlin as per detail B.

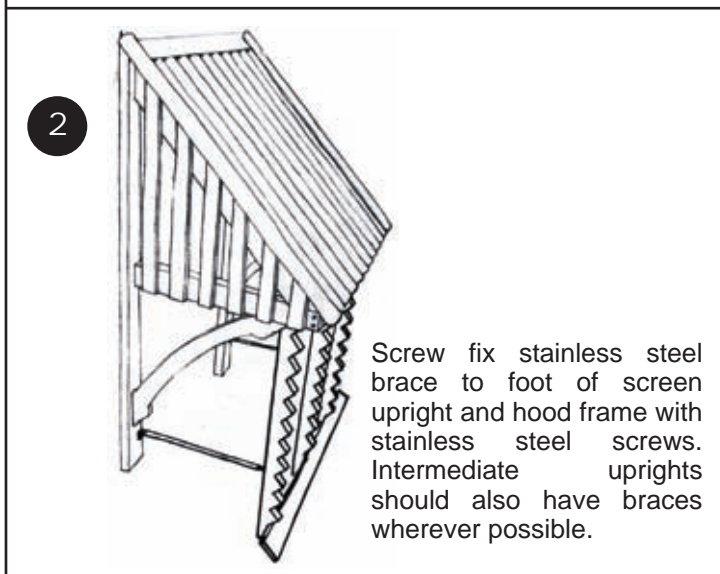

Screw fix stainless steel brace to foot of screen upright and hood frame with stainless steel screws. Intermediate uprights should also have braces wherever possible.

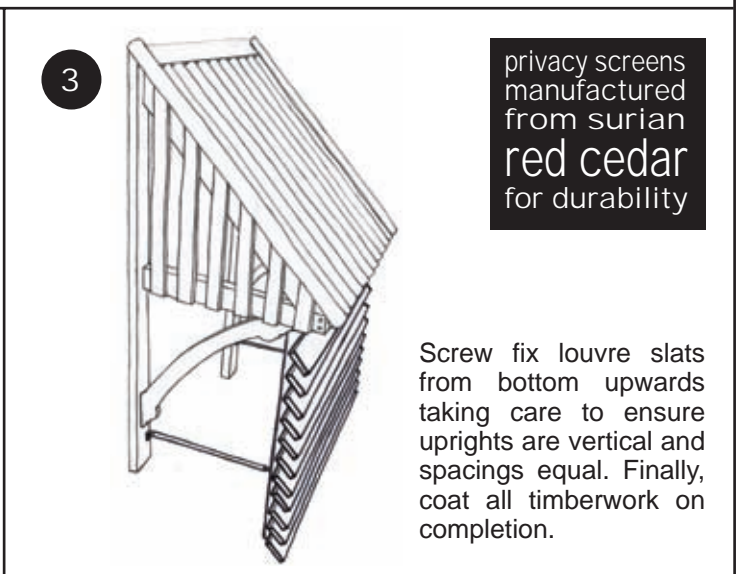

privacy screens  
manufactured  
from surian  
**red cedar**  
for durability

Screw fix louvre slats from bottom upwards taking care to ensure uprights are vertical and spacings equal. Finally, coat all timberwork on completion.



Flat blade design

20% off  
pricelist

## Louvre privacy screen pricelist supplied as DIY kits

height	width →				with centre support							
	700	800	900	1000	1100	1200	1300	1400	1500	1600	1700	1800
800	\$215	\$226	\$237	\$248	\$286	\$297	\$308	\$319	\$329	\$340	\$351	\$362
900	\$221	\$231	\$242	\$253	\$292	\$303	\$313	\$324	\$335	\$346	\$357	\$367
1000	\$226	\$237	\$248	\$259	\$297	\$308	\$319	\$330	\$340	\$351	\$362	\$373
1100	\$232	\$243	\$253	\$264	\$303	\$314	\$324	\$335	\$346	\$357	\$368	\$378
1200	\$237	\$248	\$259	\$270	\$308	\$319	\$330	\$341	\$352	\$362	\$373	\$384
1300	\$243	\$254	\$265	\$275	\$314	\$325	\$336	\$346	\$357	\$368	\$379	\$390
1400	\$249	\$259	\$270	\$281	\$320	\$330	\$341	\$352	\$363	\$374	\$384	\$395
1500	\$254	\$265	\$276	\$286	\$325	\$336	\$347	\$358	\$368	\$379	\$390	\$401

HOOD + SCREEN  
COMBO BUYS **5% OFF**  
total combined price of  
hoods & screens when  
purchased together

ALL PRICES  
INCLUDE  
**GST**

THE  
**WOODWORKERS**  
COMPANY